

Article number: 0101219  
 Description: Retaining ring A 410 DIN 471  
 Spring steel  
 Note: Fitted with ZGA pilers

## Measures

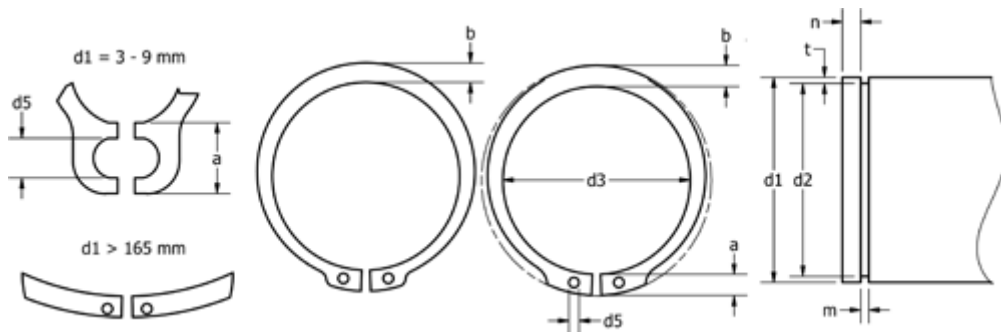

a max	=	FN kN	= 1269.0	s	= 7.00
AN mm <sup>2</sup>	= 7615.0	FRg kN	= 139.00	t	= 6.00
b	= 26.0	FR kN	= 1616.00	tol	= -0.89
d1	= 410	g	= 7.0	tol	= -0.15
d2	= 398.0	K kN-mm	= 3701.00	tol	= +0,90-2,00
d3	= 390.0	m min	= 7.20	Tong	= ZGA-7
d5 min	= 6.0	n abl x 1000	= 1.0	Weight kg/1000	= 999.999
Description	= A410	Nominal drive	= 18.0		